

 **Topglass<sup>®</sup>**

# Translucent Roofing Catalogue



## **Alsynite One is an internationally recognised and respected roofing product manufacturer, having designed, built and commissioned a state-of-the-art manufacturing facility in Te Rapa, Hamilton in February 2008.**

As new sheeting product development is an integral part of the company's business, Alsynite One NZ Ltd remain at the cutting edge, offering international customers state-of-the-art manufacturing equipment and processes designed to remain at the forefront of the GRP composites industry. Computerised automated production lines with advanced forming and curing techniques produce high clarity and solid panel products of all grades.

Alsynite One NZ Ltd is JAZ-ANZ accredited under the Benchmark Certification scheme. Recognised in more than 90 countries and providing security and respect to our customers JAZ-ANZ accreditation not only guarantees accurate systems processes but also ensures consistent and monitored product legally certified to AS 4256.3:2006.

Alsynite One NZ Ltd product brands include the much respected **Laserlite**® polycarbonate roofing range, **Topglass**® GRP sheeting, **Alsynite One Industrial turbine rotary ventilators** and Tubular Skylights, and an extensive range of fastenings and roofing accessories. Alsynite One also distribute a full range of **Polygold Pure** formaldehyde-free fibreglass insulation in Blanket and Biscuit segments.

These products and an extensive range of roofing accessories form a natural adjunct to the translucent sheeting range that ensures Alsynite One continues to meet ongoing customer requirements.









Topglass® GC is also manufactured in Bangkok, Thailand by I-Conns Asia; in HCM City, Vietnam by Naaco Plastic JSC It is also manufactured in Australia under licence to FGW Corporation Pty Ltd in Perth Western Australia, and Laserlite Building Products in Sydney – servicing South, East and North Australia markets. All Topglass® GC roofing is manufactured using the same innovative Alsynite One NZ Ltd processes – this ensures that customers can be assured and trust that when they order a genuine Topglass® GC product, it will be manufactured to the same high standards that have been set by Alsynite One NZ Ltd.

For handling, installation and further technical details contact your Alsynite One representative or visit [alsynite.co.nz](http://alsynite.co.nz)

Alsynite One NZ Ltd reserves the right to change, modify, or withdraw products from the market, either permanently or temporarily, at any time without notice and without incurring any liability.

- © Alsynite One NZ Ltd
- ® Topglass
- ® Registered Trademark



 <b>Topglass®</b>	UV Stabilised Commercial Grade Reinforced Translucent Roofing	4-5
 <b>Topglass® GC</b>	Gelcoated Natural Roof Lighting	6-7
 <b>Topclad™ GC</b>	Heavy-Duty, Corrosion Resistant, Solid-Coloured Roofing and Cladding System	8-9
 <b>Topglass® GC SPF</b>	Solar Protective Gelcoated Natural Roof Lighting	10-11
 <b>Topglass® GC Ultra-Safe</b>	High impact, Corrosion Resistant Glass Reinforced Roofing and Cladding	12-13
 <b>Topclad® GC Ultra-Safe</b>	Heavy-Duty, Corrosion Resistant, Solid-Coloured Roofing and Cladding System	14-15
 <b>Twinskin Systems</b>	Heat Reducing Translucent Roofing	16-17
 <b>Triple Skin Systems</b>	Translucent Roofing	18
 <b>Topglass® FR50</b>	Fire Retardant Translucent Roofing	19
Installation Instructions		20-21
Project Solutions Chart		22
Technical Information		23
Panel Testing		24-25
Maintenance for Topglass®		26



## Introduction

Topglass® translucent roofing has been specifically developed to combat the effect of UV rays and atmospheric pollutants without the yellowing and rapid product degradation associated with commonly available glass reinforced roof sheeting. Utilising major technological advances developed by both Alsynite One NZ and its suppliers, Topglass® is supplied as a cost-effective product encompassing a purpose developed UV stabilised composite resin system and surface protected with an Alsynite One proprietary weather surface coating providing longer term effective light transmission.

## Key Benefits

- Topglass® is manufactured from an acrylic modified resin system, reinforced with high quality glass fibre rovings
- Topglass® utilises surface coatings which are especially formulated and designed to provide high quality long term natural light transmission
- Topglass® encompasses in-built NZA-5 UV inhibitors which prevent early degradation, yellowing and embrittlement of the sheet
- The product is oven cured and profiled to ensure maximum binding and strength
- The non-porous weather surface prevents water absorption and osmosis
- Reduced fibre show in comparison to standard commercial grade translucent roofing products
- The weather surface retains its smooth finish for a greater period of time providing self-cleaning benefits
- An extremely flexible product providing innovative product variations in meeting design criteria
- Topglass® is extremely cost-effective UV resistant translucent roof sheeting
- Closer inspection of Topglass® indicates that only minimal air bubbles are retained in the composite, resulting in improved aesthetics, extreme clarity and improved strength

## Applications

- Commercial, industrial, institutional and other projects where long-term high quality lighting is required
- School/Kindergarten and public outdoor areas requiring excellent UV protection

## Special Applications

- Topglass® can be supplied encompassing a purpose developed corrosive resistant resin for use in areas of extreme corrosion
- All Topglass® products can be supplied in various Twinskin systems providing excellent thermal/acoustic benefits and energy savings
- Topglass® can be supplied tinted to reduce light and heat transmission. This is recommended due to the long term clarity of the sheet
- Topglass® roofing profiles can be supplied in reduced width sheet if so require

## Surface Coatings

The Topglass® weather surface polyester coating incorporates UV inhibitors and offers protection against early yellowing and degradation of the sheet. In specific applications and where minor corrosion may affect the underside of the sheeting, an Alsynite One NZ proprietary high sheen corrosion resistant surface can be supplied in place of the standard polyester film.

## Operating Temperature

The operating temperature range of Topglass® is - 40° to +110° C.

## Colours and Tints

Topglass® is available in standard colours of Clear, Orchid, Opal and Cool. Other colours to suit specific design criteria are available on request. MOQ may apply for non-standard colours.

## Fire Retardant

Topglass® can be supplied as fire retardant sheeting. See Topglass® FR50.

## Safety

To comply with the requirements of AS 1562.3: 2006 Part 3 Plastic, translucent roofing products are classified as “Brittle Roofing” and therefore not suitable to support foot traffic. With exception of Topglass® GC Ultra-Safe. Safety mesh should be installed under all translucent roofing.

## Weathering Performance

Topglass® incorporates UV inhibitors. Extended UV testing shows a significant reduction in UV degradation and yellowing as shown. Topglass® sheeting will have a service life of at least 25 years in normal conditions.

## Specification

The Translucent roofing shall be Topglass® reinforced polyester roof sheeting as manufactured by Alsynite One NZ Ltd to comply with AS 4256.3: 2006 JAS-ANZ Certification Licence No. 2349.

The sheeting shall be measured in g/m<sup>2</sup> or mm (sheet thickness) and manufactured to conform to the nominated roofing and cladding profile. Installation shall be carried out in accordance with the requirements of AS 1562.3: 2006.

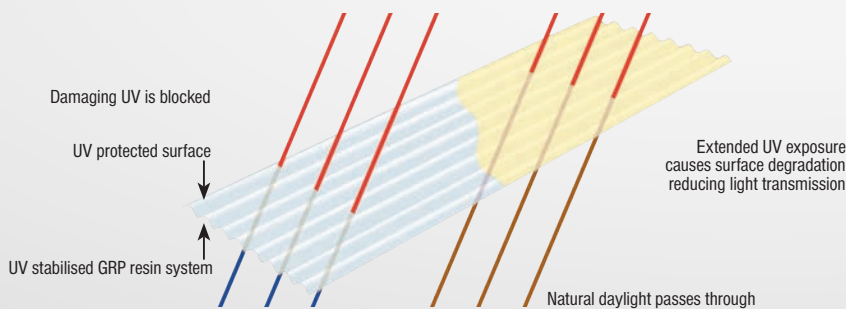

Compare the discolouration of sheeting after accelerated weathering

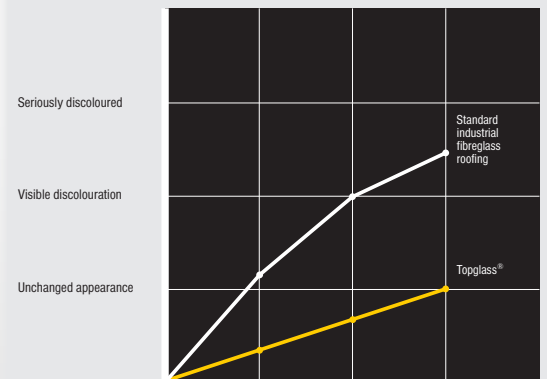

4,000 hours weatherometer testing simulates 10 years exposure in normal conditions

↑ AGE

Topglass® out-performs conventional fibreglass materials. Topglass® retains light transmission and discolouration resistance after 4,000 hours continuous UV exposure (equivalent to 10 years in “normal” conditions).

\*Topglass® cool provides blocking of 99.9% UVA and 100% UVB harmful UV Light.

Solar heat gain	227w/m <sup>2</sup>
Shading co-efficient	.33
Solar head gain co-efficient	0.20
UVA transmittance	.1%
UVB transmittance	0.0%

## Visible Light and Solar Transmission

Weight	Colour							
	Clear		Orchid		Opal		Cool*	
	Light	Solar	Light	Solar	Light	Solar	Light	Solar
1800g/m <sup>2</sup> (1.1mm)	84%	75%	78%	69%	70%	52%	n/a	n/a
2400g/m <sup>2</sup> (1.5mm)	74%	65%	65%	60%	58%	49%	33%	22%
3660g/m <sup>2</sup> (2.5mm)	62%	58%	60%	56%	47%	40%	n/a	n/a

Light and Solar transmission information is issued as a guide only and based on interpretation of natural exposure testing. Full test information is available from Alsynite One NZ Ltd.

## WARRANTY



Topglass® is supported by a comprehensive 25 year warranty and a 15 year light transmission warranty. For written project warranties, contact Alsynite One NZ Ltd.



## Introduction

Topglass® GC is the flagship of the Topglass® natural lighting family of products, and uses an innovative manufacturing process developed by Alsynite One NZ, whereby a 130 micron\* EXO-SET 206 Premium Gelcoat is applied to the weather surface of the sheeting.

Offering exceptional resistance against corrosive atmospheres and providing protection against solar deterioration, Topglass® GC brings additional benefits to building designers and owners. Topglass® GC can also be supplied in solid colours providing an excellent alternative to metal roofing and cladding systems in corrosive environments.

## Key Benefits

- Manufactured from an acrylic modified polyester resin system and incorporating additional UV stabilisers, Topglass® GC utilises antistatic high quality glass fibre rovings to give maximum strength during the curing and bonding process;
- The ultimate benefit of the Topglass® GC product over general purpose grades of GRP natural roof lighting products is the addition of Alsynite One's UV-stabilised 130 micron\* EXO-SET 206 Gelcoat surface which is a reactive thermo-set to provide a high gloss surface;
- Topglass® GC, which is manufactured to meet the requirements of AS 4256:3.2006, is economical and provides flexibility whilst resisting UV degradation and yellowing much longer than is commonly experienced with general purpose grade translucent roofing products;
- Harmful UV Rays remain a major concern for today's building designers. Topglass® GC can be supplied in a variety of pigments and can be supplied as Topglass® GC SPF. This innovative Gelcoat additive provides excellent UVA and UVB block and offers exceptional heat and light data.

## Applications

- Roof and wall lighting to all commercial, industrial, institutional and other buildings requiring long term natural lighting without early surface degradation;
- School/Childcare Centres and public outdoor areas requiring good UV protection.

## Special Applications

- Topglass® GC can be pigmented to meet varying light and solar transmission requirements;
- Heavy-duty solid colour-fast roofing and cladding can be supplied to replace traditional roofing and cladding products for use where corrosion exists. These are manufactured as Topclad™ GC.

UV STABILISED  
NON-DELAMINATING CARRIER FILM

130 MICRON\* EXO-SET GELCOAT WEATHER  
SURFACE

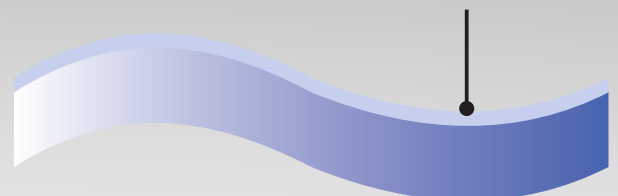

\* Nominal Thickness 130 Micron.

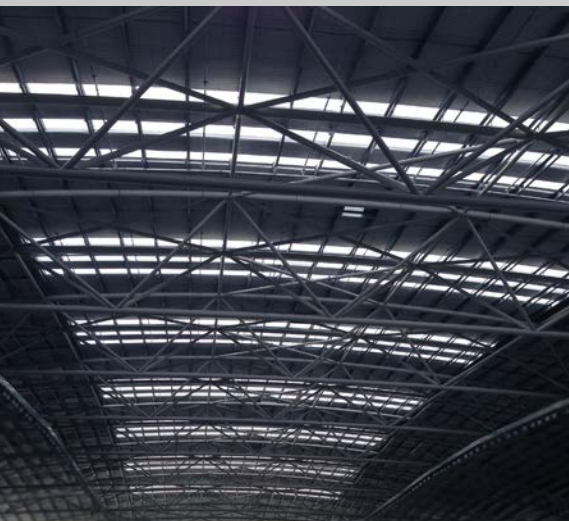

### Surface Coatings

The Alsynite One 130 micron\* EXO-SET 206 Premium Gelcoat weather surface used in the manufacture of Topglass® GC gives very good protection against solar deterioration. The reverse side of the sheeting is protected with a 20 micron UV stabilised Polyester film. Where corrosive atmospheres exist which affect the underside of the sheeting, Alsynite One NZ Proprietary high sheen corrosive resistant surface can be supplied in place of the film.

### Colours and Tints

Topglass® GC is available in standard colours of Clear, Orchid, Opal and Cool. Other colours to suit specific design criteria are available on request. MOQ may apply for non-standard colours.

### Noise Reducing Sheeting

Topglass® GC can be supplied as an effective noise reducing sheeting. See: Topglass® Twinskin Systems and Triple Skin Systems.

### Operating Temperature

The operating temperature of Topglass® GC is -30°C to + 70°C.

### Fire Retardant

Topglass® GC can be supplied as fire retardant sheeting. See Topglass® FR50.

### Safety

To comply with the requirements of AS 1562.3: 2006 Part 3 Plastic, translucent roofing products are classified as “Brittle Roofing” and therefore not suitable to support foot traffic. With exception of Topglass® GC Ultra-Safe. Safety mesh should be installed under all translucent roofing.

### Severe Corrosion Environments

In areas where corrosion is severe Topglass® GC can be manufactured using a special purpose Vinyl Ester corrosion-resistant resin system.

### Specification

The Translucent roofing shall be Topglass® GC reinforced Polyester roof sheeting as manufactured by Alsynite One NZ Ltd to comply with AS 4256.3: 2006 JAS-ANZ Certification Licence No. 2349. The sheeting shall be measured in g/m<sup>2</sup> or mm (sheet thickness) and manufactured to conform to the nominated roofing and cladding profile. Installation shall be carried out in accordance with the requirements of AS 1562.3: 2006.

Visible Light and Solar Transmission								
Weight	Clear		Orchid		Opal		Cool	
	Light	Solar	Light	Solar	Light	Solar	Light	Solar
1800g/m <sup>2</sup> (1.1mm)	84%	75%	78%	69%	70%	52%	n/a	n/a
2400g/m <sup>2</sup> (1.5mm)	74%	65%	65%	60%	58%	49%	33%	22%
3660g/m <sup>2</sup> (2.5mm)	62%	58%	60%	56%	47%	40%	n/a	n/a

Light and Solar transmission information is issued as a guide only and based on interpretation of natural exposure testing. Full test information is available from Alsynite One NZ Ltd.

## WARRANTY



Topglass® GC is supported by a comprehensive 25 year warranty and a 20 year visible light and solar transmission warranty. For written project warranties, contact Alsynite One NZ Ltd.



## Introduction

In some highly corrosive industrial sites and areas of high salt contamination, high build paint coatings on roofing and cladding substrates such as aluminium and steel may not perform as expected. To address these concerns, Alsynite One New Zealand manufactures unique solid-coloured heavy-duty roofing and cladding material utilising advanced GRP technology to formulate a corrosive resistant cladding system for use as an innovative replacement for traditional materials.

## Key Benefits

- The surface coatings and substrate used in the manufacture of Topclad™ GC have been designed specifically to withstand corrosive atmospheres. The added benefit provided by Topclad™ GC, is the highly polished corrosive resistant surface on the underside of the sheet.
- Topclad™ GC is solid-coloured to match modern roof colours (Subject to pigment availability) this is achieved by applying an Alsynite One 130 micron\* EXO-SET 206 Gelcoat layer to the GRP sheeting substrate.
- Advanced technology associated with the Alsynite One NZ Gelcoat manufacturing process allows different solid colour pigmentation to be applied to each side of the sheet, particularly important where the underside of the sheet is not covered by a membrane;
- Available to match a wide range of roof profiles including flat sheet;
- Lightweight cladding for easy handling and installation;
- Reduces solar heat transmission;
- Manufactured to any length.
- Lower freight costs

## Applications

- Wool scouring plants
- Fertiliser buildings
- Poultry and animal sheds
- Acid plants and smelters
- Effluent tank cladding
- Extreme marine environments
- Buildings in geothermal areas
- Compost plants
- Abattoirs
- Galvanising plants
- Tanneries

## Special Applications

Where corrosion may be of concern to the underside of the roofing and cladding system, an Alsynite One NZ Proprietary high polished corrosion resistant surface can be applied to the underside of the sheet. At additional cost, Vinyl Ester Resin can be incorporated for maximum protection.

## Weight/Thickness of Sheeting

The standard weight for Topclad™ GC is 2800g/m<sup>2</sup> (1.9mm). Other weights up to 3660g/m<sup>2</sup> (2.5mm) are available subject to minimum order.

## Surface Coatings

The Alsynite One 130 micron\* EXO-SET 206 Premium Gelcoat weather surface used in the manufacture of Topclad™ GC Offers superior sheet clarity and unsurpassed long-term resistance against UV degradation.

## Colours

Topclad™ GC provides excellent opportunity to replicate the colours normally associated with pre-painted metal roofing and cladding products. Topclad™ Standard colour range is, Titania, Grey Friars, Silver, Mist Green, and Sandstone Grey. Other colours to suit specific design criteria are available on request. All Topclad™ GC Products are subject to minimum order quantities.





### Operating Temperature

Topclad™ GC will not become brittle with age and will not soften or crack within the designed temperature operating range of -30°C to +70°C.

### Fire Retardant

Topclad™ GC can be supplied as fire retardant sheeting. See Topglass® FR50.

### Moisture

Where Topclad™ GC will be in continuous contact with moisture, Alsynite One NZ Ltd Technical department should be contacted prior to ordering.

### Safety

To comply with the requirements of AS 1562.3: 2006 Part 3 Plastic, translucent roofing products are classified as “Brittle Roofing” and therefore not suitable to support foot traffic. With exception of Topglass®/Topclad™ GC Ultra-Safe. Safety mesh should be installed under all translucent roofing.

### Thermal Expansion

2.2 x 10.5 cm / cm °C E.g. 7m long sheet with a 40°C temperature change = 2.2 x 10.5 x (10 x 100) x 7 x 40 = 6.16mm per 7m length at 40°C temperature rise.

### Chemical Resistance

- Topclad™ GC has no known chemical reaction with any construction materials;
- The sheeting is resistant to solar deterioration and most corrosive atmospheres;
- Unaffected by solvents, including hydrocarbons, and provides excellent resistance to most corrosive acids and alkalis.

### Specification

The Translucent roofing shall be Topclad™ GC reinforced Polyester roof sheeting as manufactured by Alsynite One NZ Ltd to comply with AS 4256.3: 2006 JAS-ANZ Certification Licence No. 2349.

The sheeting shall be measured in g/m<sup>2</sup> or mm (sheet thickness) and manufactured to conform to the nominated roofing and cladding profile. Installation shall be carried out in accordance with the requirements of AS 1562.3: 2006.

### Flashings

For flashings information contact Alsynite One NZ Ltd.

### Product Handling

Care must be taken when handling and installing the product to avoid stress damage and/or scratching of the surface.

### WARRANTY

Topclad™ GC is supported by a comprehensive 25 year warranty and a 20 year light transmission warranty. For written project warranties, contact Alsynite One NZ Ltd.





## Introduction

A revolutionary and innovative Gelcoated natural lighting product developed using Alsynite One NZ Technology and aptly named Topglass® SPF - Solar Protection Feature. Encompassing a unique manufacturing process similar to that used in the design and manufacture of modern sunglass eyewear, Topglass® SPF Solar control roof lighting, selects and singles out Infrared (heat) plus harmful Ultraviolet rays, thereby preventing heat build-up and UV damage to Stock and Plant.

## Key Benefits

- Provides maximum visible light transmission whilst preventing unwanted solar transmission into a building.
- Reduces energy and air-conditioning costs along with the need for additional artificial lighting.
- Virtually eliminates harmful UVA and UVB UV rays from entering a building.
- The sheet is aesthetically unique, providing innovative design characteristics for building designers.
- Long term effective light transmission.
- Excellent project warranties.
- Topglass® SPF is JAS-ANZ certified to AS 4256:3.2006 Licence No. 2349.

## Applications

- Food manufacturing buildings;
- Warehouses and retail outlets storing food and fresh produce;
- Shopping centres and supermarkets;
- Bulk paper stores;
- Temperature-sensitive environments requiring high quality long-term natural lighting.

## Weather Surface Coating

Alsynite One 130 micron\* EXO-SET 206 Premium Gelcoat weather surface.

## WARRANTY

Topglass® GC SPF is supported by a comprehensive 25 year warranty and a 20 year light transmission warranty. For written project warranties, contact Alsynite One NZ Ltd.



## Product Variations

Product	Visible Light Transmission	Total Solar Transmission
Topglass® SPF 4	64%	50%
Topglass® SPF 8	49%	36%



## Operating Temperature

The operating temperature of Topglass<sup>®</sup> GC SPF is -30°C to +70°C.

## Safety

To comply with the requirements of AS 1562.3: 2006 Part 3 Plastic, translucent roofing products are classified as “Brittle Roofing” and therefore not suitable to support foot traffic. With the exception of Topglass<sup>®</sup> GC Ultra-Safe. Safety mesh should be installed under all translucent roofing.

## Roof Profiles

Topglass<sup>®</sup> GC SPF 4 and Topglass<sup>®</sup> GC SPF 8 are manufactured to match all commonly available roofing and cladding profiles, including flat sheet.

## Severe Corrosive Environments

In areas where corrosion is severe, Topglass<sup>®</sup> GC SPF can be manufactured incorporating special purpose Vinyl- Ester Resin. Where internal corrosion exists such as indoor swimming pools, a proprietary corrosion resistant and high polished reverse side surface can be supplied.

## Weight/Thickness of Sheeting

Topglass<sup>®</sup> GC SPF Products are manufactured in varying sheet thickness as follows: Roof profiles: 1800g/m<sup>2</sup> (1.1mm) to 3660g/m<sup>2</sup> (2.5mm) Flat sheet: 1800g/m<sup>2</sup> (1.1mm) – 4000g/ m<sup>2</sup> (2.7mm)

## Specification

The translucent roofing shall be Topglass<sup>®</sup> GC SPF 4 and SPF 8 Gelcoated natural roof lighting system, JAS-ANZ Certified and as manufactured by Alsynite One NZ Ltd to comply with AS 4256:3.2006, Licence No. 2349. The sheeting shall be measured in g/m<sup>2</sup> or mm (sheet thickness) and manufactured to conform to the nominated roofing and cladding profile. Installation shall be carried out in accordance with the requirements of AS 1562.3: 2006.

## Test Reports

Full Vipac test reports are available on Topglass<sup>®</sup> GC SPF 4 and SPF 8 for Single-Skin and Twinskin System applications. Measurement and Calculation of Twinskin Solar Optical Properties, 6 March 2008. Vipac Engineers and Scientists Ltd, Melbourne Vic. This information is available on request.

Full Vipac Mechanical test reports pertaining to Topglass<sup>®</sup> 2400 gsm and Topglass<sup>®</sup> GC Ultra-Safe series, August 2014 available on request

To comply with the requirements of AS 1562.3: 2006 Part 3 Plastic, translucent roofing products are classified as “Brittle Roofing” and therefore not suitable to support foot traffic. With exception of Topglass<sup>®</sup>/Topclad™ GC Ultra-Safe. Safety mesh should be installed under all translucent roofing.

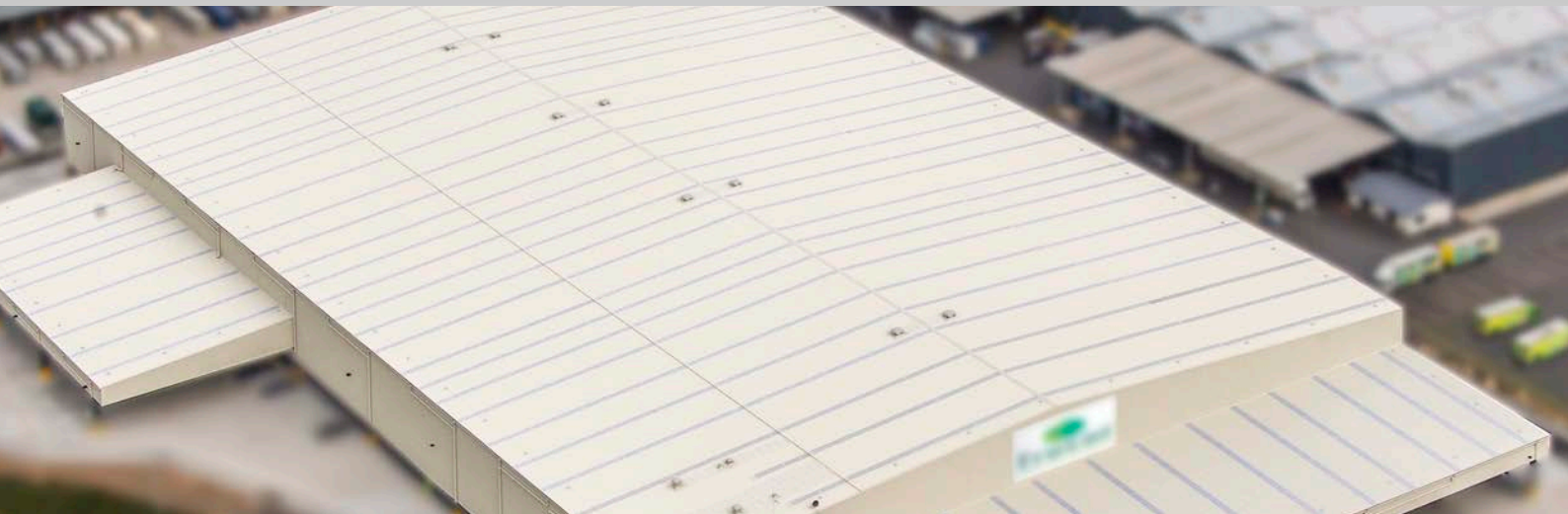

## Introduction

Industry concerns relating to Natural Roof-Lighting being classified as “brittle” and therefore possibly posing a danger to foot traffic on the roof, has led to Alsynite One NZ purpose develop a heavy-duty and high impact roof lighting system to alleviate these concerns. Aptly named Topglass® GC Ultra-Safe, the product utilises a heavy-duty, woven roving reinforcing system positioned within the resin matrix, thereby providing exceptional strength. Further, the innovative fastening system jointly developed by Alsynite One NZ Ltd and the Company’s fastening supplier provides maximum security to any foot traffic across the roof once installed whether this is day, night or in times of restricted visibility.

## Key Benefits

- Topglass® GC Ultra-Safe is manufactured utilising heavy-duty woven roving enclosed within the resin matrix which in turn provides a structural capability not normally available with traditional translucent roofing materials.
- Topglass® GC Ultra-Safe meets the impact strength tests of AS/NZS 4040.4 and satisfies the requirements of AS 4256.3 alleviating the need for safety mesh to be installed under the sheeting. This is of particular benefit to building designers who face corrosive atmospheres damaging the safety mesh zinc coating.
- As the roving matrix runs both longitudinally and laterally within the sheet, Topglass® GC Ultra-Safe demonstrates exceptional high impact strength.
- Alsynite One 130 micron\* EXO-SET 206 Premium Gelcoat weather surface provides long term light transmission and is supported by a 20 year weather surface structured warranty.
- Corrosion resistant when installed in wide range of aggressive environments.
- Excellent spanning capabilities.
- Topglass® GC Ultra-Safe meets the impact strength tests of AS 4256.3 clause 11.3, AS 4040.1, and AS 1562 alleviating the need for safety mesh, rather than just a roof lighting product.

## Applications

- Waste water treatment plants
- Salt Extraction Facilities
- Severe marine environments
- Natural roof lighting where safety mesh is not installed
- Wood Pulp and Paper Plants
- Educational facilities and Public Assembly areas where there is a danger of people climbing onto a roof
- Fertiliser Plants
- Chemical and Powder-coating Plants
- Wool scouring facilities

## Special Applications

- In very severe corrosive environments the Topglass® GC Ultra-Safe resin system can be fortified using Vinyl Ester to provide maximum protection.
- Topglass® GC Ultra-Safe can be supplied as a heavy-duty solid coloured roofing and cladding material to replace metal roofing products for use in corrosive environments.



## Weather Surface Coating

Alsynite One 130 micron\* EXO-SET 206 Premium Gelcoat weather surface used in the manufacture of Topglass® GC Ultra-Safe Offers superior sheet clarity and unsurpassed long-term UV resistance against premature yellowing.

## Weight/Thickness of Sheeting

Topglass® GC Ultra-Safe is supplied as standard weight of 3660g/m<sup>2</sup>.

## Colours

The standard colours of Topglass® GC Ultra-Safe are translucent Clear and Opal. Other pigments are available subject to minimum order quantity.

## Profiles

Topglass® GC Ultra-Safe is available to match most common roofing profiles.

## Safety

Whilst Topglass® GC Ultra-Safe is classified as heavy-duty, meets the impact test of AS 4040.4, satisfying the requirements of AS 4256.3, and can support foot traffic, long term degradation and or post roof installation impact damage can seriously affect the performance of the sheeting. In order to comply with the requirements of AS 1562.3:2006 Part 3 Plastic, protect the weather surface coating and provide continual structural strength, all FRP products should be protected from foot traffic, therefore a suitable proprietary aluminium walkway is always recommended. Consult Alsynite One NZ Ltd for recommended systems.

## Specification

The translucent sheeting and/or roofing and cladding shall be Topglass® GC Ultra-Safe as manufactured by Alsynite One NZ Ltd to comply with AS 4256.3 JAS-ANZ Certification Licence No 2349. The sheeting shall conform to the nominated roofing and cladding profile and installed in accordance with the requirements of the Alsynite One Topglass® GC Ultra-Safe proprietary safety fixing system.

Light and Solar Transmission		
Tint	Visible Light Transmission	Solar Transmission
Clear	61%	56%
Opal	58%	49%

## WARRANTY

Topglass® GC Ultra-Safe is supported with a 20 Year weather surface structured warranty and a 10 year structured loss of light transmission warranty. Full warranty conditions and written project warranties are available from Alsynite One NZ.



\* Nominal Thickness 130 Micron.



## Introduction

A Hybrid product derived from Topglass<sup>®</sup> GC Ultra-Safe with the additional feature of Solid Colours used to manufacture Topclad<sup>™</sup> GC.

Topclad<sup>™</sup> GC Ultra-Safe can be installed in most highly corrosive industrial sites and areas where there is a danger to foot traffic on the roof. Due to these concerns Alsynite One NZ developed the heavy-duty, high impact roof system to alleviate concerns of walking on Fibreglass structured roofing.

Topclad<sup>™</sup> GC Ultra-Safe utilises the same heavy-duty, woven roving reinforcing system as Topglass<sup>®</sup> GC Ultra-Safe with the additional features of a solid colour pigment added to the Gelcoat layer to formulate a corrosive resistant cladding system for use as an innovative replacement for traditional materials.

## Key Benefits

- Topclad<sup>™</sup> GC Ultra-Safe is manufactured utilising the same heavy-duty woven roving enclosed within the resin matrix as Topglass<sup>®</sup> GC Ultra-Safe.
- The surface coatings and substrate used in the manufacture of Topclad<sup>™</sup> GC Ultra-Safe have been designed specifically to withstand corrosive atmospheres while the woven roving provides a structural capability that alleviates the need for safety netting under the product.
- Topclad<sup>™</sup> GC Ultra-Safe meets the impact strength tests of AS/NZS 4040.4 and satisfies the requirements of AS 4256.3.
- Topclad<sup>™</sup> GC Ultra-Safe is solid-coloured to match modern roof colours (Subject to pigment availability)
- Advanced technology associated with the Alsynite One 130 micron\* EXO-SET 206 Gelcoat weather surface manufacturing process allows different solid colour pigmentation to be applied to each side of the sheet, particularly important where the underside of the sheet is not covered by a membrane.

## Applications

- Areas where there is a danger of persons climbing onto a roof
- Fertiliser Plants
- Chemical and Powder-coating Plants
- Wool scouring facilities
- Waste water treatment plants
- Salt Extraction Facilities
- Severe marine environments
- Wood Pulp and Paper Plants
- Fertiliser buildings
- Poultry and animal sheds
- Acid plants and smelters
- Galvanising plants
- Effluent tank cladding

## Weather Surface Coating

Alsynite One 130 micron\* EXO-SET 206 Gelcoat weather surface used in the manufacture of Topclad<sup>™</sup> GC Ultra-Safe Offers superior sheet clarity and unsurpassed long-term resistance against UV degradation.



## Operating Temperature

Topclad<sup>™</sup> GC Ultra-Safe will not become brittle with age and will not soften or crack within the designed temperature operating range of -30°C to +70°C.

## Safety

Topclad<sup>™</sup> GC Ultra-Safe is classified as heavy-duty, meets the impact test of AS 4040.4, satisfying the requirements of AS 4256.3, and can support foot traffic, long term degradation and or post roof installation impact damage can seriously affect the performance of the sheeting. In order to comply with the requirements of AS 1562.3:2006 Part 3 Plastic, protect the weather surface coating and provide continual structural strength, all FRP products should be protected from foot traffic, therefore a suitable proprietary aluminium walkway is always recommended. Consult Alsynite One NZ Ltd for recommended systems.

## Roof Profiles

Topclad<sup>™</sup> GC Ultra-Safe is available to match most common roofing profiles with the exception of Trough/Tray type profiles.

## Severe Corrosive Environments

- Topclad<sup>™</sup> GC Ultra-Safe has no known chemical reaction with any construction materials;
- The sheeting is resistant to solar deterioration and most corrosive atmospheres;
- Unaffected by solvents, including hydrocarbons, and provides excellent resistance to most corrosive acids and alkalis.

## Weight/Thickness of Sheeting

Topclad<sup>™</sup> GC Ultra-Safe is supplied as standard weight of 3660g/m<sup>2</sup>.

## Specification

The translucent sheeting and/or roofing and cladding shall be Topclad<sup>™</sup> GC Ultra-Safe reinforced Polyester roof sheeting as manufactured by Alsynite One NZ Ltd to comply with AS 4256.3 JAS-ANZ Certification Licence No 2349. The sheeting shall conform to the nominated roofing and cladding profile and installed in accordance with the requirements of the Alsynite One Topclad<sup>™</sup> GC Ultra-Safe proprietary safety fixing system.

## Test Reports

- 1 Impact Resistance AS/NZS 4257.6:1994
- 2 Shear Strength ASTM D732-10
- 3 Compressive Strength ISO 604-2003
- 4 Flexural Strength ASTM D790-10
- 5 Specific Gravity ASTM D792-08
- 6 Tensile Strength ISO 527-1 & ISO 527-2
- 7 Coefficient of Linear Expansion ASTM D696-98
- 8 Thermal Conductivity C518-10

## WARRANTY

Topclad<sup>™</sup> GC Ultra-Safe is supported by a comprehensive 25 year warranty and a 20 year light transmission warranty. For written project warranties, contact Alsynite One NZ Ltd.





## Introduction

Where potential condensation issues are of concern, Alsynite One manufacture a Twinskin System that offers a solution to this problem. Two independently formed sheets of Topglass® are laid over each other to form an effective air gap between the sheets. Condensation evaporates and this prevents water droplets entering the building. Alsynite One Twinskin Systems also offers building occupants a reduced noise level from outside influences, as the system offers an effective acoustical reducing solution.

## Key Benefits

- Manufactured from an acrylic modified resin system, reinforced with high quality glass fibre rovings
- Reduces internal heat build-up and offers a passive natural lighting concept
- Effective noise reducing system
- Eliminates condensation in most applications
- Manufactured and supplied to side-lap most current popular steel roofing profiles
- Manufactured and supplied in one length as a complete system, ridge-to-gutter or ridge-to-step if a stepped roof

## Applications

Commercial, industrial, institutional sports stadiums and other projects where long term high quality natural lighting is required.

## Special Applications

Alsynite One Twinskin System can be supplied to meet varying light and solar transmission requirements to meet any design criteria.

## Surface Coatings

Topglass® GC is the preferred choice for Twinskin Systems for the external weather surface. Alsynite One 130 micron\* EXO-SET 206 Gelcoat weather surface offers very good protection against solar deterioration. A 20 micron film can be applied to the reverse side of the laminate or where corrosive atmospheres exist which may affect the underside of the sheeting. Alsynite One proprietary high level corrosive resistant protective sheen can be supplied.

## Colours and Tints

Alsynite One Twinskin Systems typically are supplied with a low pigment additive in the top sheet (Orchid) and a clear support under sheet.

This configuration offers the building interior a soft passive environment without direct sunlight penetration. However any combination of pigment colours is readily available, consult Alsynite One for pigment level recommendations.

## Heat Reducing Sheeting

As an added barrier against solar heat build-up Twinskin Systems can include SPF 4 and SPF 8 formulations.



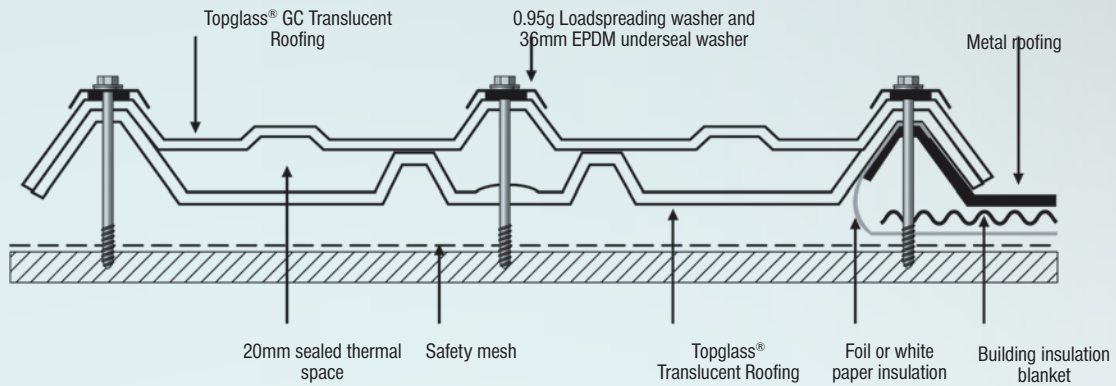

NOTE:  
 • Gutter end sealed with purpose made Alsynite One closed cell foam strip  
 • Twinskin clear roofing at 2400g/m<sup>2</sup> (1.5mm thick) provides light transmission of 70%

## Operating Temperature

Alsynite One Twinskin Systems operating temperature is -30°C to +70°C

## Fire Retardant

Alsynite One Twinskin Systems operating temperature is -30°C to +70°C supplied as Topglass® GC FR50.

Alsynite One Twinskin Systems can be supplied as Topglass® FR50

## Safety

To comply with the requirements of AS 1562.3:2006 Part 3 Plastic, translucent roofing products are classified as brittle roofing and therefore not suitable to support foot traffic – with the exception of Topglass® GC Ultra-Safe. Note that safety mesh should be installed under all translucent roofing.

## Severe Corrosion Environments

In areas where corrosion is severe Twinskin Systems can be supplied with a vinyl ester resin system.

## Specification

The translucent Twinskin System shall be Alsynite One reinforced polyester roof sheeting manufactured by Alsynite One to comply with AS4256.3:2006 JAZ-ANZ certification licence number 2349. The sheeting shall be measured in g/m<sup>2</sup> or mm (sheet thickness) and manufactured to conform to the nominated roofing and cladding profile. Insulated Translucent Roofing systems can be manufactured to meet building fire standard groups 3, 2 and 1-S classifications. Test report available from Alsynite One. Installation shall be carried out in accordance with the requirements of AS 1562.3:2006.

## Twinskin Roofing System - Profile Exploded

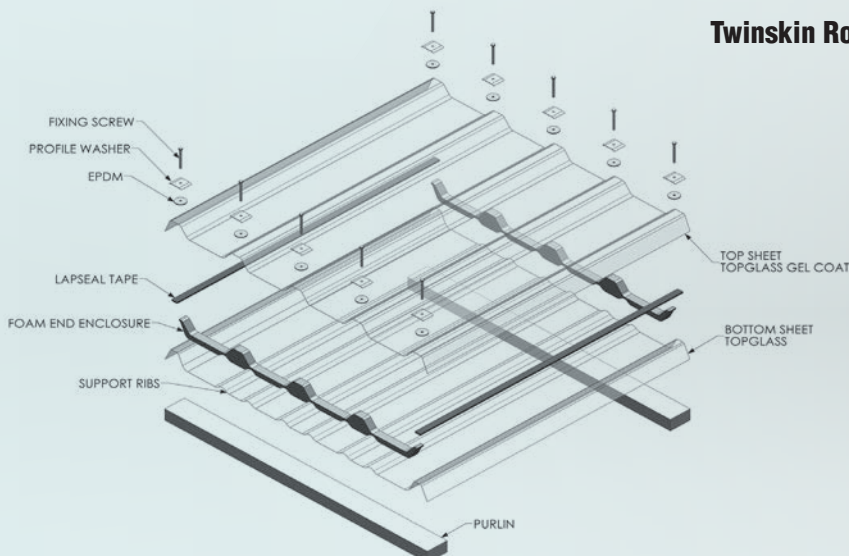

## WARRANTY

Alsynite One Twinskin Systems are supported by a comprehensive 25 year warranty and a 20 year light transmission warranty. For written project warranties, contact Alsynite One NZ Ltd.



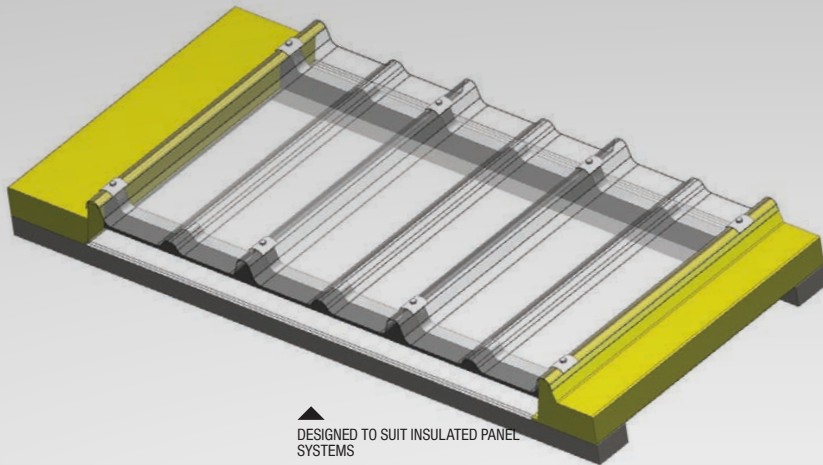

## WARRANTY



Topglass® GC Ultra-Safe, Triple Skin Systems are supported with a 25 year weather surface warranty and a 20 year structured loss of light transmission warranty. Full warranty conditions and written project warranties are available from Alsynite One NZ.

## Introduction

Topglass® Triple Skin Systems are primarily designed as a suitable fully insulated natural lighting roofing product. Topglass® GC Ultra-Safe is utilised as a weather surface sheet and one sheet of 10mm Laserlite® Twinwall form the bottom layers. Offering increased thermal and acoustical properties these systems are utilised in conjunction with insulated panel products.

## Key Benefits

- Manufactured from an acrylic modified resin system reinforced with high quality glass rovings, with the incorporation of a reinforced woven roving matrix and Laserlite® Twinwall.
- Increased thermal resistance and increased acoustical properties.
- Eliminates condensation in most applications.
- Manufactured and supplied to match insulated panel systems.

## Applications

Compliments commercial buildings that require insulated roofing panel construction, and provides natural lighting with the added benefit of offering good thermal resistance.

## Surface Coatings

Topglass® GC is the preferred choice for Triple Skin Systems for the external weather surface. Alsynite One 130 micron\* EXO-SET 206 Gelcoat weather surface offers very good protection from solar deterioration. Triple Skin Systems can be supplied in most weights g/m<sup>2</sup> but Topglass® GC Ultra-Safe is recommended for this system.

## Colours and Tints

Triple Skin Systems can be supplied in a variety of tints but generally is supplied as translucent clear.

## Operating Temperature

Triple Skin Systems operating temperature is -30°C to + 70°C

## Safety

Topglass® Triple Skin Systems supplied as Topglass® GC Ultra-Safe is classified as heavy-duty, meets the impact test of AS 4040, satisfying the requirements of AS 4256.3 and can support foot traffic, long term degradation and or post roof installation impact damage can seriously affect the performance of the sheeting.

In order to comply with the requirements of AS 1562.3 2006 part 3 plastic, protect the weather surface coating and provide continual structural strength, all GRP products should be protected from foot traffic, therefore a suitable proprietary aluminium walkway is always recommended.

Consult Alsynite One NZ Ltd for recommended systems.

## Specification

The translucent sheeting shall be Topglass® GC Ultra-Safe, Triple Skin System 3660 g/m<sup>2</sup> (unless specified otherwise) manufactured to comply with AS 4256.3 JAZ-ANZ certification licence no. 2349.

The sheeting shall conform with the nominated roofing and cladding profile and be installed in accordance with the requirements of the Alsynite One Topglass® Ultra-Safe proprietary safety fixing system.

\* Nominal Thickness 130 Micron.



## Introduction

Topglass® FR50 is designed and supplied as a fire and smoke retardant natural lighting system for use in commercial and industrial buildings. This type of resin system alters the flammability point of the sheeting; however it should be noted Alsynite One supplies all GRP sheeting in this brochure as natural lighting/cladding products only.

## Key Benefits

- Reinforced polyester fire retardant sheeting that has been specifically formulated using fire retardant materials for use in commercial building applications and educational institutions.
- Glass reinforced polyester fire retardant sheeting that can be considered into building designs that specifically require reduced ignitability, flame propagation and heat and smoke release over conventional resin systems.

## Applications

- Schools and educational institutions
- Public assembly areas
- Combustible areas with high fire risk
- Where egress from a building in the event of fire may be restrictive

## Special Applications

BRANZ test report FH 4937 October 2012 contained in this literature refers to Topglass® FR50. Contact Alsynite One NZ Ltd for advice on more advanced fire and smoke retardant resin systems.

## Surface Coatings

Topglass® FR50 is supplied with the Alsynite One's 130 micron\* Exo-Set 206 SPF enhanced Gelcoat system. Topglass® FR50 is supplied as a translucent roofing product and is now available and offers increased solar values as can be experienced with Topglass® GC SPF4 the SPF enhancement stabilises the products appearance offering increased weather surface stability in colour retention than previously experienced.

## Safety

To comply with the requirements of AS 1562.3: 2006 Part 3 Plastic, translucent roofing products are classified as "Brittle Roofing" and therefore not suitable to support foot traffic. With exception of Topglass® GC Ultra-Safe. Safety mesh should be installed under all translucent roofing.

## Specification

The Translucent roofing shall be Topglass® FR50 reinforced Polyester roof sheeting as manufactured by Alsynite One NZ Ltd to comply with AS 4256.3: 2006 JAS-ANZ Certification Licence No. 2349. The sheeting shall be measured in g/m<sup>2</sup> or mm (sheet thickness) and manufactured to conform to the nominated roofing and cladding profile. Installation shall be carried out in accordance with the requirements of AS 1562.3: 2006.

## Profiles

Topglass® FR50 is available ex stock in a limited number of roofing profiles.

## Test Reports

BRANZ test report **Topglass FR50**  
 FH 4937 October 2012  
 NZBC Group number 3

\* Nominal Thickness 130 Micron.

## WARRANTY

Topglass® FR50 is supported by a comprehensive 25 year warranty and a 20 year light transmission warranty. For written project warranties, contact Alsynite One NZ Ltd.



## Product Handling and Storage Instructions for All Products

- Store sheeting in a dry location and protect from possible wind damage prior to installation.
- Sheeting should not be dragged across objects or other products as it may affect the performance and aesthetics of the roof sheet.
- Care should be taken when loading the translucent roofing onto the roof to avoid bending or distortion of the sheet.
- Sheeting that becomes wet in bundles and is required to be stored should be separated and dried prior to storage.

## Recommended Installation Guidelines

- Sheeting may be cut using an abrasive disc or fine tooth saw (use protection gloves and approved face mask).
- GRP Translucent roofing is not designed to support foot traffic and unless specifically excluded in AS 1562.3:2006, clause 2.4.3 requires the use of safety mesh under all translucent roof sheeting. Refer to Figure 5.
- Alsynite One NZ Purlin barrier strip must be installed between the translucent roof sheeting and the safety mesh at the purlin line. Refer to Figure 5.
- Ensure the purlins are correctly spaced and that they are in line.
- GRP fibreglass roofing should always be installed over the main roof cladding at both lapping edges. Refer to Figure 1
- Ensure the weight/thickness of the sheet combined with the selected roofing profile will meet the spanning requirements. Contact Alsynite One NZ Ltd for specific design advice or refer Load Span Capability Chart.
- Ensure that the correct weathering surface of the sheeting is uppermost as the durability and any warranty is dependent on placing the sheet the correct side up.
- Where two translucent roof sheets are laid side by side, the mid span support shall extend under the metal roofing sheet by a minimum 400mm with fastening through at least two ribs of the metal roofing on either side of the GRP sheet.

- Mid span supports shall not be used where more than two translucent sheets are adjacent to one another.
- If more than two sheets of Topglass® Roofing products are to be used side by side, contact Alsynite One NZ Ltd for specific guidelines.
- Where roof installations require Topglass® or Topclad™ to be laid side-by-side, it is recommended that the use of Lap Seal Tape be implemented in these situations, therefore preventing possible water ingress over the laps.

Figure 2

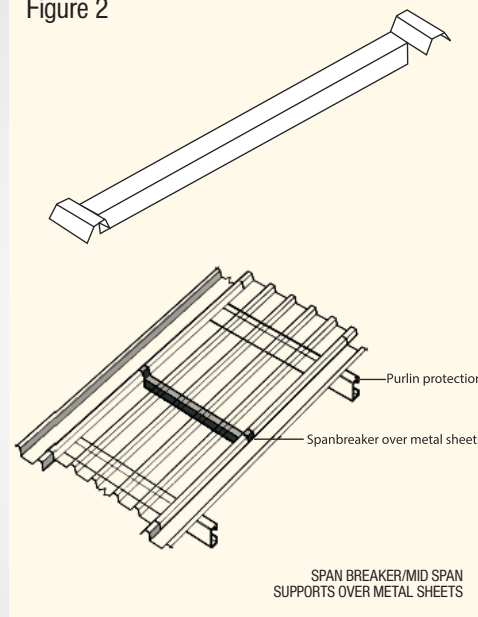

## Stop Ends

Install stop ends to the top of the translucent sheeting as follows.

Use a right-angled folded flashing to the full height of the corrugation or rib, fixed with rivets and sealant.

- Severe conditions: Use 0.9mm aluminium.

## Method 1

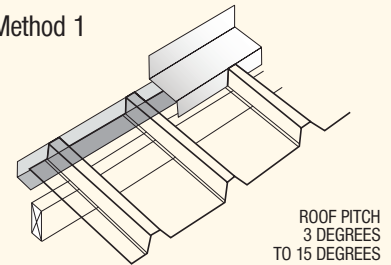

- Moderate conditions: Use pre-painted metal.

Note: This can also be used in an exposed site or high or very high wind zone for steeper pitched roofs.

Use Alsynite One NZ Ltd approved closed cell profiled foam strip fitted close to the screw fixing points.

## Sealants

The use of silicone should be restricted to end laps only as when set the sealant restricts the ability of the sheet to expand and contract. The use of sealants under side laps is not recommended. In some particular building designs i.e. curved roofing and where the pitch may fall below the recommended minimum pitch, Alsynite One NZ Ltd Lap seal tape can be applied to lapping edges. Expansion and contraction of dissimilar roofing materials should be taken into prior consideration.

## Method 2

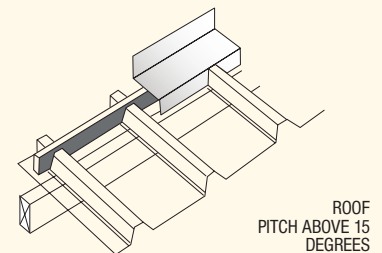
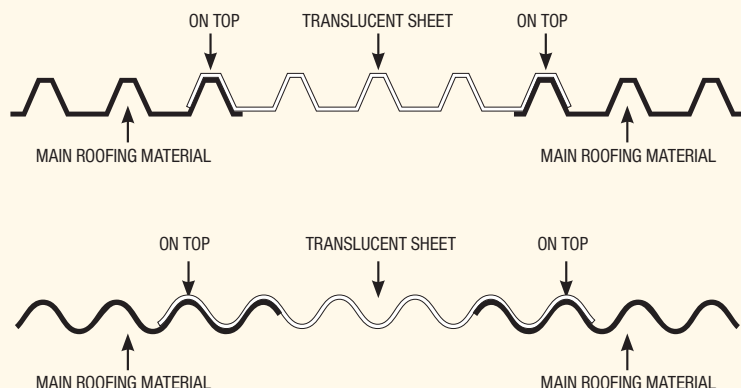
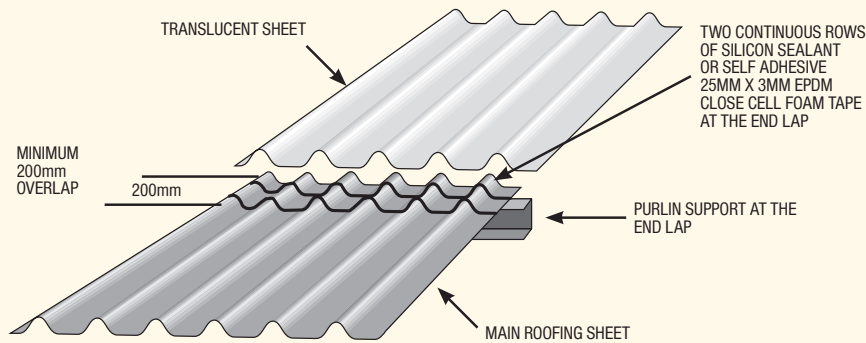

Figure 1



## End Laps

- Minimum recommended length of end lap of GRP sheets and/or with metal profile sheeting is 200mm.
- Position of lap over purlin - it is recommended the bottom end of the lap sheet be within 50mm of the lower side of the purlin.
- Position of the seal - the bottom bead should be within 25mm from the bottom of the top sheet in lap, and the top bead of seal within 50mm of the top of the bottom sheet.



## Side Lap Fixing

Side laps should be fixed at a maximum spacing of 600mm to prevent wind uplift and leakage, and these fixings shall be through the top of the rib.

- When fixing GRP to metal, pre-drill the appropriate oversize hole in the GRP and screw through the centre of the hole into the metal using a self-drilling hex head screw 12g or 14g complete with load spreading washer and 36mm EPDM sealing washer. Refer to Figure 3.

The fastener shall be as for the main roof cladding and will be used in conjunction with a Alsynite One NZ Ltd approved load spreading washer constructed of 0.95mm unpainted/pre-painted metal or 1.2mm aluminium to match the main cladding material. In a highly corrosive environment, consideration should be given to the use of stainless steel or other appropriate corrosive resistant material.

Inserted under the load spreading washer will be a 36mm EPDM sealing washer which is to be correctly seated to provide an effective seal. Fasteners should be inserted through the top centre of the rib/corrugation.

Other fastener methods such as 32mm Weatherlock washers may be suitable based on sheet length and load characteristics. Alsynite One NZ Ltd should be contacted for further clarification and advice.

- All fastener holes should be pre-drilled over-size to accommodate the expansion and contraction of the sheets as follows:

- Sheets up to 6m 8mm Ø hole**
- Sheets 6m to 9m 10mm Ø hole**
- Sheets 9m to 12m 12mm Ø hole**
- Sheets 12m to 28m 16mm Ø hole**

Note: It is important to centre the fixing in the oversize hole to ensure the sheet has equal movement around the fixing.

Note: Where wind loads exceed 1.5kPa, contact Alsynite One NZ Ltd for specific design advice. Do not overdrive the

fasteners so that deformation of the sheet occurs.

## Fastener Pattern

- Corrugated profile end supports and end laps: Fix side laps and every 2nd corrugation.
- Corrugated profile internal supports or purlins: Fix side laps and every 3rd corrugation.
- 5 rib low trapezoidal profiles (19mm to 30mm): On all purlins fix every rib.
- High trapezoidal profiles (50mm to 120mm): On all purlins fix every rib.
- 7 to 8 rib medium trapezoidal profiles (33mm to 49mm) end support and end laps: Fix every rib.
- 7 to 8 rib medium trapezoidal profiles (33mm to 49mm) internal support or purlins: Fix side laps and every 2nd rib.
- Deck profiles - fix every rib.

## Further Technical Assistance

The installation instructions are a guide to assist with installation of translucent roof sheeting. For non-standard building design such as draped curve roofs, contact Alsynite One NZ Ltd for technical advice prior to ordering product or commencing the project.

Figure 3

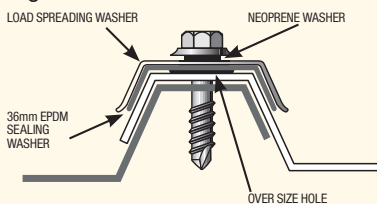

Figure 4

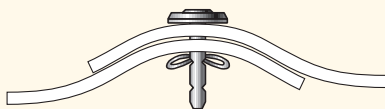
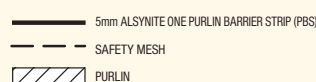
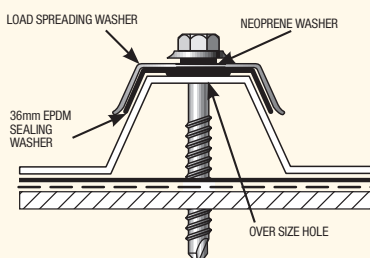

Figure 5



## Project Solutions

	Topglass®	Topglass® GC SPF	Topglass® FR50	Twinskin System	Topclad™ GC	Topglass® GC	Topglass®/Topclad™ Ultra-Safe	Laserlite® 1000	Laserlite® 2000	Laserlite® 3000	Laserlite® Twinwall	Flashings
Competitive priced translucent roof sheet for domestic and commercial use	•							•				
Best value translucent roof sheet with UV stabilised surface	•					•		•				
Long term light transmitting, UV stabilised surface	•	•		•		•	•		•	•	•	•
UVA & UVB greater than 95% blocking	•	•	•	•	•	•	•	•	•	•	•	•
Swimming pool cover translucent roof sheet						•	•					
Fire and smoke retardant translucent roof sheeting			•				•	•	•	•		
Heat reducing & reflecting translucent roof sheeting Solar Control Translucent roof sheeting		•		•			•			•		
Heavy-duty fibreglass roofing and cladding		•										
Coloured Translucent Roof sheeting					•		•	•	•	•		
Solid Colour GRP roofing and cladding						•						
Corrosive resistant translucent roof sheet					•		•					
Corrosive resistant solid coloured GRP heavy-duty roofing and cladding	•				•	•	•					
Aesthetically unique translucent sheeting					•		•					
10 Year Warranty		•										
15 Year Warranty												•
20/10 Year Warranty			•	•	•	•	•					
25/20 Year Warranty	•					•						
Lifetime Platinum Warranty - 16 Year Hail		•							•	•		
Lifetime Gold Warranty - 10 Year Hail							•					
Lifetime Platinum Warranty - 5 Year Hail											•	

## Load Span Capabilities (Based on 1.5kPa distributed uplift load)

Grade	1800g/m <sup>2</sup>	2000g/m <sup>2</sup>	2400g/m <sup>2</sup>	2800g/m <sup>2</sup>	3050g/m <sup>2</sup>	3660g/m <sup>2</sup>	3660g/m <sup>2</sup>	Curved roofing minimum drapecurve radius (m)	
	1800g/m <sup>2</sup>	2200g/m <sup>2</sup>	1800g/m <sup>2</sup>	1800g/m <sup>2</sup>	1800g/m <sup>2</sup>	1800g/m <sup>2</sup>	1800g/m <sup>2</sup>	1800g/m <sup>2</sup>	2200g/m <sup>2</sup>
Sheet thickness	1.1mm	1.2mm	1.5mm	1.9mm	2.0mm	2.5mm	Ultra-Safe	1.1mm	1.3mm
<b>Profile (to match)</b>									
Corrugated, Custom Orb	1.000(s)	–	1.250	1.400	1.500	1.600	2.500	3.8	4
5 Rib (Trimdek etc)	1.200(s)	–	1.500	1.600	1.700	2.000	2.500	8	9
Plumbdek, Trimline	1.200(s)	–	1.500	1.600	1.700	2.000	2.500	8	9
MC700, MC750, MC770	1.200(s)	–	1.500	1.600	1.700	2.000	2.500	8	9
Ribline 960	–	–	1.500	1.600	1.700	2.000	2.500	8	9
Hi Five, Six Rib	1.200(s)	–	1.500	1.600	1.700	2.000	2.500	8	9
MC1000, Metric™, Windek™	1.200(s)	–	1.500	1.600	1.700	2.000	2.500	8	9
V Rib™	1200	–	1.500	1.600	1.700	2.000	2.500	12	14
ST7, Silbery7, LT7™, V8, ST900, Multirib, BB900™, MF 900	–	–	1.800	1.950	2.100	2.400	2.500	12	14
Multispan, MC930, Mega 5, ST963, DP955, Metcom 965, Maxispan, SS900, RM900	–	–	2.200	2.400	2.600	3.000	2.500	16	18
Purlindek	1.900(s)	–	2.650	2.900	3.300	3.600	2.500	18	21
Concealed clip Deck Profiles	–	1.200(s)	1.500	1.550	1.700	2.000	2.500	16	18
Supersix	1.150(s)	–	1.500	1.550	1.650	1.950	2.500	16	17

Alsynite One has utilised the NZMRM Test bed facility to test industrial roof profiles in excess of 2.0kPa UDL. Product spanning can be increased by increasing the weight (thickness) of the sheet. Based on 1.5kPa UDL the information contained in the chart is relative to intermediate Purlins, where the sheeting is in single runs and is to be supported by the main roofing and cladding at each side lap. It is important that Purlin spacing be reduced for curved structures, and Alsynite One should be consulted for specific design criteria.

(s) Denotes standard translucent roof sheet weight ex stock. For all other profiles and weights contact Alsynite One.

## Profiles

All Topglass® products are available to match common roof profiles, subject to minimum quantity order and raw material availability.

## Colour Variation

Due to variations in raw materials shade variations can occur between manufacturing batches.

## Weight/Thickness of Sheeting

Alsynite One GRP roofing products can be manufactured in varying thicknesses:

Roof profiles: 1800g/m<sup>2</sup> (1.1mm) – 3660g/m<sup>2</sup> (2.5mm)

## Sheet Lengths

As Topglass® products are manufactured in New Zealand, all roofing profiles can be manufactured to any length.

## Design Considerations

Metal roofing profile height is an important design consideration where GRP natural lighting will be installed in conjunction with long lengths of metal roofing. Very low roof pitches (5 degrees or less) combined with low profile metal roofing risk water ingress. Alsynite One recommends in this instance roofing profiles with at least a minimum of 32mm should be utilised in these applications.

Please consult Alsynite One where wind loads exceed 1.5 kPa (kilopascal) for recommended spanning information.



## TESTS AND STANDARDS

Component Test	Test Standard	Component Test	Test Standard
Impact Resistance	AS/NZS 4257.6:1994	Specific Gravity	ASTM D792-08
Shear Strength	ASTM D732-10	Tensile Strength	ISO 527-1 & ISO 527-2
Compressive Strength	ISO 604-2003	Coefficient of Linear Expansion	ASTM D696-98
Flexural Strength	ASTM D790-10	Thermal Conductivity	C518-10

## IMPACT STRENGTH

Parameter	Test	Value	
	AS/NZ 4256.3	<b>2400gsm</b>	<b>3660gsm</b>
Mass (kg)		0.223	0.223
Drop Height (m)		0.905	0.905
Gravity (m/s)		9.81	9.81
E Impact (J)		1.98	1.98
No. of Samples Tested		40	40
No. of Failed Samples		0	0

## GENERAL

	Test	Value	
		<b>2400gsm</b>	<b>3660gsm</b>
Specific Gravity	ASTM D792-08	1.43	1.44



## MECHANICAL

	Test	Value	
		2400gsm	3660gsm
Flexural Strength Modulus (MPa)	ASTM D792-08	7822	7730
Flexural Strength (MPa)	ASTM D792-08	223	289
Tensile Strength at Maximum Load (MPa)	ISO 527-1 & ISO 527-2	21.9	137
Tensile Strain at Yield (%)	ISO 527-1 & ISO 527-2	1.10	1.93
Shear Strength (MPa)	ASTM D732-10	77.8	81.3
Compressive Strength (MPa)	ISO 604-2003	124	166

## THERMAL

	Test	Value	
		2400gsm	3660gsm
Thermal Conductivity K Value Btu-in/hr-ft <sup>2</sup> -°F	ASTM C518-10	0.249802	0.357473
Thermal Conductivity K Value W/m-K	ASTM C518-10	0.3603	0.05456
Thermal Resistance R Value Hr-ft <sup>2</sup> -°F	ASTM C518-10	0.24711	0.37564
Thermal Resistance R Value m <sup>2</sup> -K/W	ASTM C518-10	0.0435	0.0662
Thermal Resistance R/in Hr-ft <sup>2</sup> -°F/Btu/in	ASTM C518-10	4.01	2.80
Thermal Resistance R/m m <sup>2</sup> -K/W/m	ASTM C518-10	27.77	19.39
Thermal Resistance U W/m <sup>2</sup> -K	ASTM C518-10	22.98	15.12

## COEFFICIENT OF LINEAR EXPANSION

	Test	Value	
		2400gsm	3660gsm
Coefficient of Linear Thermal Expansion (X10-6mm/mm °C)	ASTM D792-08	29.1	32.6

**While normal, rain provides a self washing action and surface films such as those used on Topglass® are self cleaning, the pitch of the roof coupled with the local environment can allow accumulation of dust and grime which will eventually result in possible degradation of the sheeting.**

All Alsynite One sheeting should be cleaned annually using a mild detergent and fresh water to maintain high in service light transmission and to maintain the Warranty Conditions.

- Most stains can be removed with the application of full strength detergent followed with fresh water rinse.
- **DO NOT** use abrasive cleaners.
- To maintain the sheeting in pristine condition whilst meeting the terms of the Warranty, yearly washing of the roof with a mild detergent and brush that will not damage the surface should be carried out.
- Lichen and mould can be removed using a low pressure water blaster. The roofing should be washed off with fresh water after the cleaning process.
- Every 2-3 years the roofing should be thoroughly inspected for damage, water tightness of fixings, penetrations and end lapped sheets.

 Topglass®

 Topglass® GC

 Topglass® GC Ultra-Safe

 Topglass® FR50

 Topglass® GC SPF

 Topclad GC

 Topclad® GC Ultra-Safe

 Triple Skin Systems

 Twinskin Systems

---

---

---

---

---

---

---

---

---

---

---

---

---

---

---

---

---

---

---

---

---

---

---

---

---

## contact us!

---

### **Hamilton**

7 De Leeuw Place, Te Rapa Park  
Hamilton 3200

**P** 07 850 5088

**F** 07 850 5003

**E** [sales@alsynite.co.nz](mailto:sales@alsynite.co.nz)

### **Palmerston North**

74 Malden Street, Roslyn  
Palmerston North 4414

**P** 06 356 5384

**F** 06 356 5387

**E** [palmerston@alsynite.co.nz](mailto:palmerston@alsynite.co.nz)

### **Christchurch**

18 Nga Mahi Road, Sockburn  
Christchurch 8042

**P** 03 348 3375

**F** 03 348 3376

**E** [chch@alsynite.co.nz](mailto:chch@alsynite.co.nz)

### **Invercargill**

140 Mersey Street  
Invercargill 9810